

TS/ISO Registered



# ADRIAN STEEL®

*Cargo Management Solutions for Commercial Vehicles*

# CARGO VAN EQUIPMENT

## for NISSAN NV CARGO





# CARGO MANAGEMENT SOLUTIONS



**MAKE YOUR  
NV CARGO  
WORK READY!**

Don't let all that cargo space in your NV Cargo get out of control! Adrian Steel has the storage solutions for many needs!

Choose a Work Ready Upfit to match your trade, or create your own interior with a variety of shelving, cabinets and storage units.

## **NISSAN COMMERCIAL INCENTIVE PROGRAM**

**NISSAN AND ADRIAN STEEL ARE COMMITTED BUSINESS PARTNERS AND THEY HAVE TEAMED UP TO OFFER YOU THE COMMERCIAL STORAGE PRODUCTS NECESSARY TO GROW YOUR BUSINESS.**

The Nissan Commercial Incentive Program offers qualified commercial customers substantial benefits, including your choice of upfit packages featuring shelving or ladder storage options for both Standard and High roof models. See pages 4-5 for details.

### **PROGRAM ELIGIBILITY:**

Incentives available only to a commercial business. Subject to verification and eligibility requirements. Customers who can provide one of the following eligible business documents can take advantage of the Nissan Commercial Incentive Program. All eligible business documentation must link the owner's name to the business.

- Business License
- Copies of DBA or assumed name document
- Articles of Incorporation
- Sales Tax License
- State or Federal forms showing a Federal Identification Number
- Nissan FAN code
- Verifiable D & B listing
- Municipal Business License
- State or Federal authorized business website (must have a .gov web address)
- State Occupational License for Trade (for example Plumber, Electrician, Contractor)

You must purchase or lease and take delivery of an eligible NV Cargo commercial van during the program period.

### **NEED HELP?**

Contact your local Nissan Commercial Vehicle Dealer for more information about the Commercial Incentive Program. Locate your dealer online at: [www.nissancommercialvehicles.com/dealer-locator](http://www.nissancommercialvehicles.com/dealer-locator)

Adrian Steel Product questions can be directed to your local Adrian Steel distributor. Locate your distributor online at: [www.adriansteel.com/distributors](http://www.adriansteel.com/distributors)

# PLAN YOUR WORK READY NV CARGO

## TIME IS MONEY! GET ON THE ROAD WITH EVERYTHING YOU NEED TO GET BACK TO BUSINESS.

Adrian Steel has all the storage products you will need, and the distributor network to professionally install your interior to get you serving your customers faster. Below is a guide to help you set up your work van with the equipment you need to get the job done. Build your own interior with our modular products, or start with a Work Ready Van Package (pages 18-22) and modify it to your specific needs.

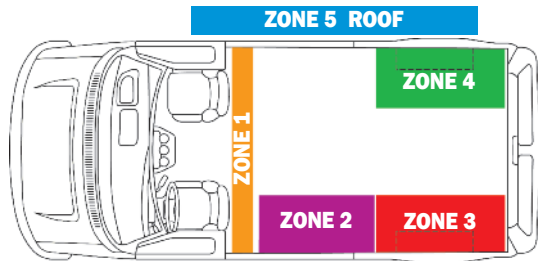

### ZONE 1 PARTITION

- Choose partition style: solid or perforated. See page 12.
- Choose the standard or 3" setback Max Comfort wing kit.
- Add accessories.
- **I need:**

### ZONES 2, 3, 4 CURBSIDE & STREETSIDE

- Use layout diagram to determine the amount of space available.
- Choose from a variety of shelving units and modules that will best organize the tools and equipment you need to carry.
- Or, choose a Work Ready Upfit, complete with a trade specific, pre-designed interior.
- **I need:**

### ADDITIONAL STORAGE

- Determine the space needed for specialty equipment.
- Add accessories to shelving and partition
- Hooks, drawers, files, screens, and more.
- See available accessories on pages 16-17.
- **I need:**

### ZONE 5 ROOF

- What do you need to carry?
- Choose from the LoadsRite drop-down ladder rack or the versatile Utility Rack.
- Add rack accessories.
- Or add a Ladder Keeper interior ladder rack.
- **I need:**

## NV CARGO WITH STANDARD PARTITION SETBACK 2011-ON

\* Subtract 3" from dimension when a Max Comfort partition wing kit is installed.

Note: Dimensions for reference only. Measure your van or contact your distributor for your exact needs.

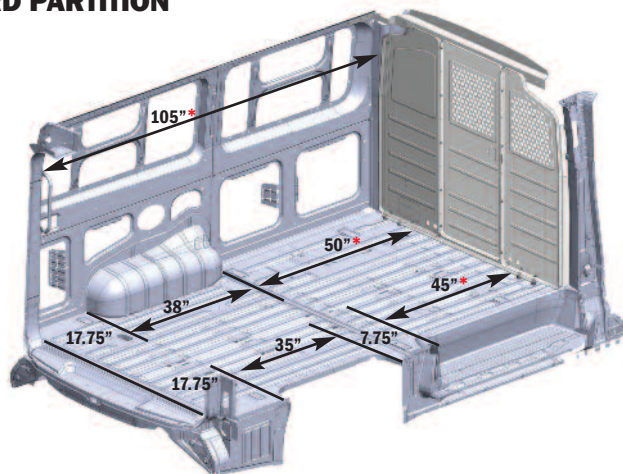

Need some help?  
Contact your local distributor!  
They can provide a wealth of information about utilizing the cargo space in your work van.  
Find your local distributor online at [adriansteel.com](http://adriansteel.com).

## INDEX

2	Nissan Commercial Incentive Program	14-15	Storage Modules
3	Plan Your Work Ready Van	16-17	Files & Van Accessories
4-5	Program Complimentary Packages	18-19	LoadsRite Ladder Racks
6-8	Program Customer Co-Pay Packages	20-21	EZ Load Ladder Rack
9	Incentive Program Accessories	21-22	Ladder Keeper & Utility Racks
10-11	Shelving	23	Index
12-13	Partitions & Accessories		

All illustrations, photos and specifications in this publication are based on the latest product information available at the time of content approval.

The right is reserved to make changes at any time, without notice, in materials, specifications and models, and also to discontinue models.



# NISSAN COMMERCIAL INCENTIVE PROGRAM

## NV CARGO - STANDARD ROOF INCENTIVE OFFERS

### CARGO MANAGEMENT SYSTEM STANDARD ROOF (#4484)

MSRP Value \$2160

**NO CHARGE!**

Item	Model	Description	Qty.
1	S1M2C2FSV	Partition	1
2	AD44LCV	ADseries shelving Unit	3
3	TA1WAD	Four Hook Bar	1
4	WKC1LCVS	Partition wing kit - std roof	1
5	RKLCV	Rail Kit	1



**NO CHARGE!**

### UTILITY PACKAGE STANDARD ROOF (#4976)

MSRP Value \$1850

**NO CHARGE!**

Item	Model	Description	Qty.
1	S1M2C2FSV	Partition	1
2	3BARRNV-W	3 Bar Utility Rack	1
3	WKC1LCVS	Partition wing kit - std roof	1

Safely transport ladders, conduit, sheet goods and more on the roof of your NV Cargo with a Utility Rack. A cargo partition inside keeps your cargo in the back and helps with cab climate control. Bolt on partition accessories allow for easy access and organization.

**NO CHARGE!**

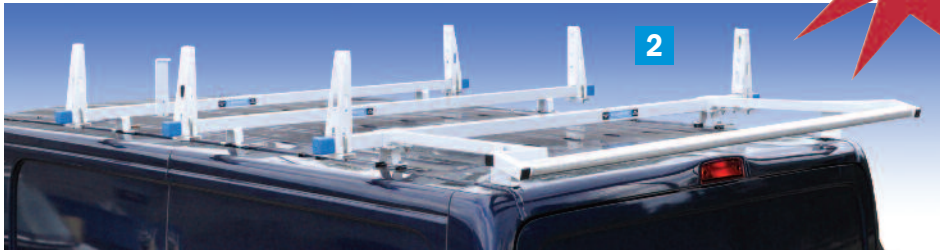

### EZ LOAD LADDER RACK PACKAGE STANDARD ROOF (#4957)

MSRP Value \$1950

**NO CHARGE!**

Item	Model	Description	Qty.
1	S1M2C2FSV	Partition	1
2	61-EZLCVC	EZ LOAD Ladder Rack	1
3	WKC1LCVS	Partition wing kit - std roof	1

**NO CHARGE!**

The all-new EZ Load ladder rack securely grips ladders for safe transport and features more ergonomic loading and unloading.



# NISSAN COMMERCIAL INCENTIVE PROGRAM

## NV CARGO - HIGH ROOF INCENTIVE OFFERS



**NO CHARGE!**

### CARGO MANAGEMENT SYSTEM HIGH ROOF (#4519)

MSRP Value \$2270

**NO CHARGE!**

Item	Model	Description	Qty.
1	S1M2C2FSV	Partition	1
2	AD44LCV	ADseries shelving Unit	3
3	TA1WAD	Four Hook Bar	1
4	WKC1LCVH	Partition wing kit - high roof	1
5	RKLCV	Rail Kit	1

### UTILITY PACKAGE HIGH ROOF (#4520)

MSRP Value \$1860

**NO CHARGE!**

**NO CHARGE!**

Item	Model	Description	Qty.
1	S1M2C2FSV	Partition	1
2	LKLCV	Ladder Keeper	1
3	WKC1LCVH	Partition wing kit - high roof	1

Keep ladders out of the elements and out of the way with an interior ladder rack. Store up to a 6 ft. step ladder inside your high roof NV Cargo. A full height cargo partition keeps your cargo in the back and helps with cab climate control. Bolt on partition accessories allow for easy access and organization.



For the latest information on the Nissan Commercial Incentive Program, please contact your Nissan Commercial Vehicle Dealer.



800.677.2726



# NISSAN COMMERCIAL INCENTIVE PROGRAM

## NV CARGO - CUSTOMER CO-PAY PACKAGES



### GENERAL SERVICE PACKAGE STANDARD ROOF (#4686NS)

MSRP Value \$3075  
Less Nissan Contribution  
**CUSTOMER CO-PAY: \$625**

### GENERAL SERVICE PACKAGE HIGH ROOF (#4686NH)

MSRP Value \$3165  
Less Nissan Contribution  
**CUSTOMER CO-PAY: \$625**

### 4686NS Standard Roof NV Cargo 4686NH High Roof NV Cargo

Item	Model	Description	Qty.
1	S1M2C2FSV	Partition	1
2	AD44LCV	ADseries Shelving Unit	3
3	TA1WAD	Four Hook Bar	1
4	WKC1LCVH or WKC1LCVS	Partition wing kit - high roof Partition wing kit - std roof	1
5	RKLCV	Rail Kit	1
6	BR36212	Parts Bin System (3-6", 2-12")	1
7	DC6	Drawer Component 6"	1
8	DV14C1	Divider	8
9	UH50	5" Hook	2
10	19	Two Drawer Medium	1
11	9	Four Drawer Shallow	1
12	BRK14EPS	End Panel Bracket	1

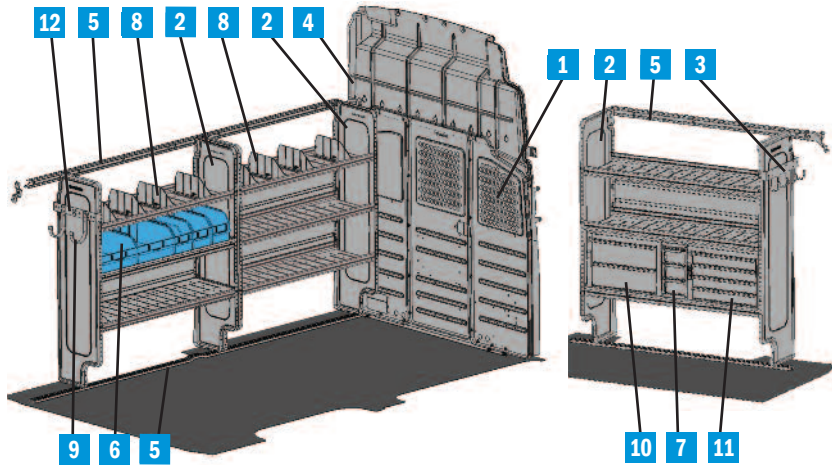

### ELECTRICAL CONTRACTOR PACKAGE STANDARD ROOF (#4687NS)

MSRP Value \$3800  
Less Nissan Contribution  
**CUSTOMER CO-PAY: \$1121**

### ELECTRICAL CONTRACTOR PACKAGE HIGH ROOF (#4687NH)

MSRP Value \$3890  
Less Nissan Contribution  
**CUSTOMER CO-PAY: \$1121**

### 4687NS Standard Roof NV Cargo 4687NH High Roof NV Cargo

Item	Model	Description	Qty.
1	S1M2C2FSV	Partition	1
2	AD44LCV	ADseries Shelving Unit	3
3	TA1WAD	Four Hook Bar	1
4	WKC1LCVH or WKC1LCVS	Partition wing kit - high roof Partition wing kit - std roof	1
5	RKLCV	Rail Kit	1
6	BR36212	Parts Bin System (3-6", 2-12")	1
7	BR76012	Parts Bin System (7-6")	1
8	DC6	Drawer Component 6"	1
9	DV14C1	Divider	8
10	CB5	Five Slot Literature Rack	1
11	DK4210	Door Kit	2
12	WRH5	Wire Reel Holder	1
13	9	Four Drawer Shallow	2
14	BRK14EPS	End Panel Bracket	4

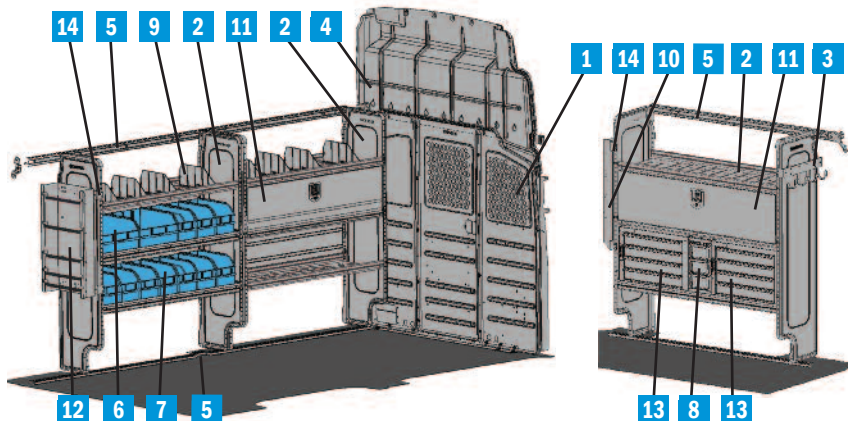



# NISSAN COMMERCIAL INCENTIVE PROGRAM

## NV CARGO - CUSTOMER CO-PAY PACKAGES



### SECURITY PACKAGE - STANDARD ROOF (#4688NS)

MSRP Value \$3465  
 Less Nissan Contribution  
**CUSTOMER CO-PAY: \$882**

### SECURITY PACKAGE - HIGH ROOF (#4688NH)

MSRP Value \$3555  
 Less Nissan Contribution  
**CUSTOMER CO-PAY: \$882**

#### 4688NS Standard Roof NV Cargo 4688NH High Roof NV Cargo

Item	Model	Description	Qty.
1	S1M2C2FSV	Partition	1
2	AD44LCV	ADseries Shelving Unit	3
3	TA1WAD	Four Hook Bar	1
4	WKC1LCVH or WKC1LCVS	Partition wing kit - high roof Partition wing kit - std roof	1
5	RKLCV	Rail Kit	1
6	UH50	5" Hook	2
7	BR76012	Parts Bin System (7-6")	1
8	DC6	Drawer Component 6"	1
9	DV14C1	Divider	12
10	CB5	Five Slot Literature Rack	1
11	DK4210	Door Kit	2
12	19	Two Drawer Medium	2
13	BRK14EPS	End Panel Bracket	3

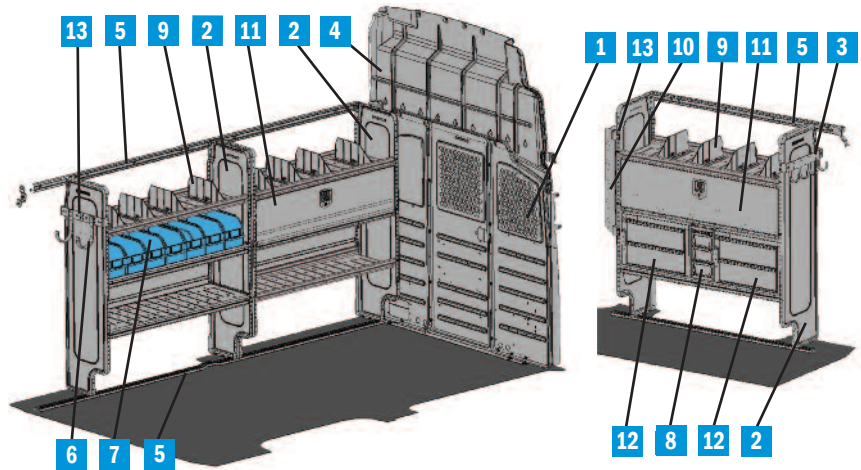

### CABLE PACKAGE - STANDARD ROOF (#4689NS)

MSRP Value \$2970  
 Less Nissan Contribution  
**CUSTOMER CO-PAY: \$549**

### CABLE PACKAGE - HIGH ROOF (#4689NH)

MSRP Value \$3060  
 Less Nissan Contribution  
**CUSTOMER CO-PAY: \$549**

#### 4689NS Standard Roof NV Cargo 4689NH High Roof NV Cargo

Item	Model	Description	Qty.
1	S1M2C2FSV	Partition	1
2	AD44LCV	ADseries Shelving Unit	3
3	TA1WAD	Four Hook Bar	2
4	WKC1LCVH or WKC1LCVS	Partition wing kit - high roof Partition wing kit - std roof	1
5	RKLCV	Rail Kit	1
6	DK4210	Door Kit	1
7	DC6	Drawer Component 6"	1
8	DV14C1	Divider	8
9	19	Two Drawer Medium	2

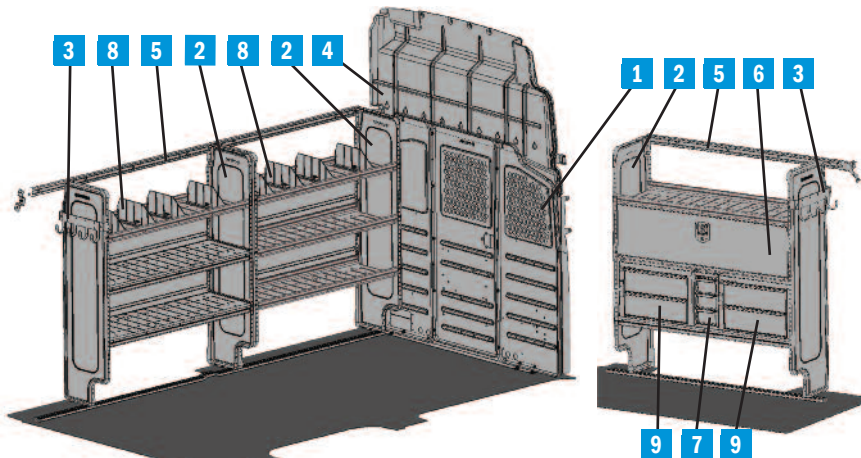

# NISSAN COMMERCIAL INCENTIVE PROGRAM

## NV CARGO - CUSTOMER CO-PAY PACKAGES



### HVAC PACKAGE - STANDARD ROOF (#4690NS)

MSRP Value \$3625  
 Less Nissan Contribution  
**CUSTOMER CO-PAY: \$992**

### HVAC PACKAGE - HIGH ROOF (#4690NH)

MSRP Value \$3715  
 Less Nissan Contribution  
**CUSTOMER CO-PAY: \$992**

### 4690NS Standard Roof NV Cargo 4690NH High Roof NV Cargo

Item	Model	Description	Qty.
1	S1M2C2FSV	Partition	1
2	AD44LCV	ADseries Shelving Unit	3
3	TA1WAD	Four Hook Bar	1
4	WKC1LCVH or WKC1LCVS	Partition wing kit - high roof Partition wing kit - std roof	1
5	RKLCV	Rail Kit	1
6	DK4210	Door Kit	1
7	BR36212	Parts Bin System (3-6", 2-12")	1
8	DC6	Drawer Component 6"	2
9	DV14C1	Divider	8
10	TH51FP	3 Tank Rack	1
11	DC12	Drawer Component 12"	1
12	19	Two Drawer Medium	1
13	BRK14EPS	End Panel Bracket	2
14	CB5	Five Slot Literature Rack	1

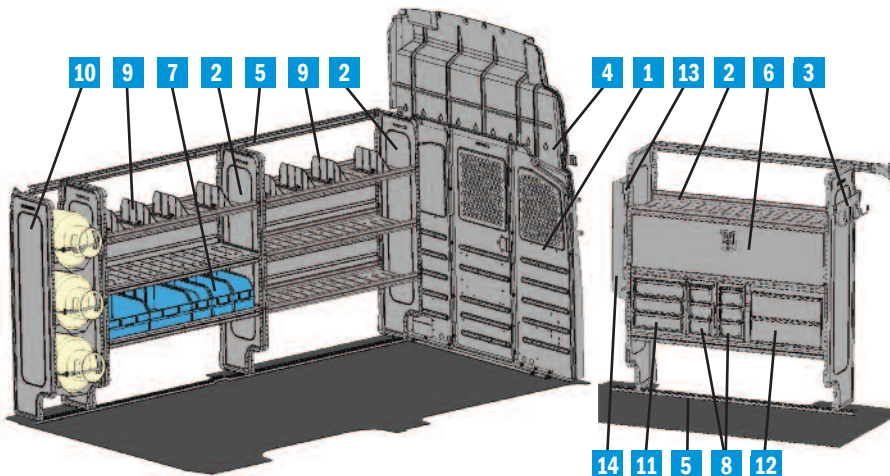

### LOCKSMITH PACKAGE STANDARD ROOF (#2255NS)

MSRP Value \$4925  
 Less Nissan Contribution  
**CUSTOMER CO-PAY: \$1900**

Item	Model	Description	Qty.
1	S1M2C2FSV	Partition	1
2	WKC1LCVS	Partition wing kit - std roof	1
3	RKLCV	Rail Kit	1
4	RKALCV	Rail Kit Adapter	1
5	MD506	Drawer & Cabinet Module	1
6	MD608	Workbench Module (18" x 26" x 84")	1
7	17A	Six Shelf Literature File	1
8	TA1	Four Hook Bar (not shown)	1



### LOCKSMITH PACKAGE HIGH ROOF (#2255NH)

MSRP Value \$5495  
 Less Nissan Contribution  
**CUSTOMER CO-PAY: \$2400**

Item	Model	Description	Qty.
1	S1M2C2FSV	Partition	1
2	WKC1LCVH	Partition wing kit - high roof	1
3	RKLCV	Rail Kit	1
4	RKALCV	Rail Kit Adapter	1
5	MD506	Drawer & Cabinet Module	1
6	MD608NH	Workbench Module	1
7	17A	Six Shelf Literature File	1
8	TA1	Four Hook Bar (not shown)	1



# NISSAN COMMERCIAL INCENTIVE PROGRAM

## NV CARGO - PROGRAM ACCESSORIES



### **PARTITION DOOR KIT (PDK1)**

**MSRP Value \$74**

The PDK1 Partition Door Kit converts an M-Series fixed center panel into a hinged door with a keyed slam latch. Includes two 6" hinges, a bulb seal and a slam latch. These features reduce vibration noise.



### **MAX COMFORT WING KITS (WKC1LCVS3) - std roof (WKC1LCVH3) - high roof**

**MSRP Value \$80**

Extend the amount of cab space by an additional 3inches with the Max Comfort Wing Kit. (Reduces cargo area by 3").



### **8" LOCKING DOOR KIT (DK4208)**

**MSRP Value \$85**

Simply bolts on to an AD44LCV ADseries shelf unit to transform an open shelf into a locking cabinet. Creates an 8" high cabinet that keeps expensive cargo out of sight. Features a recessed, key-locking T-handle.

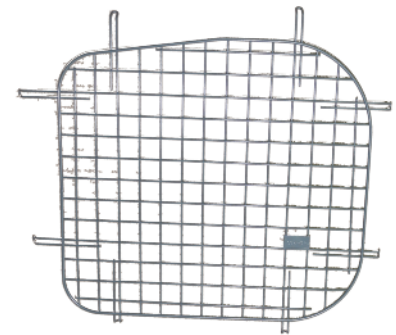

### **REAR DOORS WINDOW SCREEN KIT (60-NRD)**

**MSRP Value \$125**

Adds security to cargo area windows



### **10'6" ALUMINUM CONDUIT CARRIER (80-1)**

**MSRP Value \$470**

Transport conduit safely on the top of your standard roof NV Cargo. The Aluminum Conduit Carrier's two piece design features a lift-up door with a spring assist for easy access and lockable swivel closure for security. Constructed with .063" diamond tread aluminum with a bolt-on plate at the front to allow access to the front end of the carrier.



# ADSERIES ADJUSTABLE SHELVING

**EXCLUSIVELY FROM ADRIAN STEEL: A SHELVING PLATFORM THAT ALLOWS YOU TO PUT SHELVES WHERE YOU WANT THEM, NOT WHERE WE THINK YOU NEED THEM!**

ADseries is the next generation of cargo management solutions, engineered to optimize your work van storage and accessibility. Featuring truly ADjustable shelves, an ADaptable rail system, heavy-duty shelves and an ADvanced stamped steel end panel designed to accommodate the diverse range of cargo you need to get the job done. ADseries is ADrian made and backed by our industry-leading 3 year/36,000 mile warranty.



**ALSO AVAILABLE:  
60 SERIES SHELVING FOR THE NV CARGO HIGH ROOF**



**The HD (heavy-duty) Series**  
Utilize the height of your high roof NV Cargo with heavy-duty adjustable shelving. Features five adjustable shelves. Shelf gussets, end panel braces and full floor-rail provide extra strength.

Model	Overall Size
HD32NVH	32" x 60" x 14"
HD42NVH	42" x 60" x 14"
HD52NVH	52" x 60" x 14"





# ADSERIES ADJUSTABLE SHELVING

## ADVANCED DESIGN

Stamped steel end panels and shelves, ADseries components are strong, durable and ready to work hard. 6" knock out provides a 48" floor space to accommodate 4'x 8' sheet goods (up to 22 sheets of 1/4" dry-wall or a combination of thicknesses).

Nissan NV Cargo end panels provide 38.75" between the panels from the top to bottom maximizing aisle space.

## ADJUSTABLE SHELVES

Tools, equipment and cargo come in all shapes and sizes and until now, there hasn't been a shelving unit that is truly adjustable. The ADseries is the first of its kind where, with only a screwdriver, you can simply remove the front shelf bolts and move the shelf where you need it. Shelves can be adjusted in one inch increments and provide the most flexible shelving solution available.

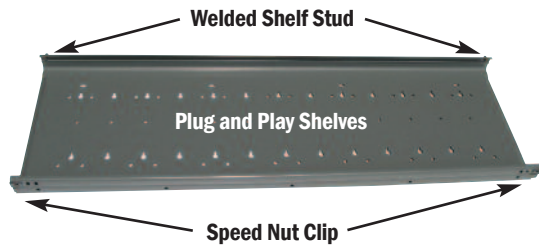

## ADAPTABLE INTERIOR

Everyone likes to set their work van up their own way. The new ADseries shelving lets you position the shelving where you need it. Exclusive to the ADseries, the unique rail system enables you to reposition the shelving in the van, increasing the available space for trade specific equipment. All of this is done without removing bolts, plugging holes and redrilling the van!

## ADD ACCESSORIES

Businesses change over time and your van interior should be able to change with your needs. Plug and Play shelves have prepunched holes that allow adding storage solutions easily! ADseries dividers simply snap in place, drawer units simply bolt in and door kits can be added to lock your more valuable parts and equipment. Many Adrian Steel accessories can be added to the ADseries shelving with the rail adapter kits and end panel brackets.

## ADSERIES SHELF UNITS AND RAIL KITS

Model	Size	Description
AD26LCV	26"W x 50"H x 14"D	fits Nissan NV Cargo
AD32LCV	32"W x 50"H x 14"D	fits Nissan NV Cargo
AD44LCV	44"W x 50"H x 14"D	fits Nissan NV Cargo
AD50LCV	50"W x 50"H x 14"D	fits Nissan NV Cargo
RKLCV	Rail System	fits Nissan NV Cargo

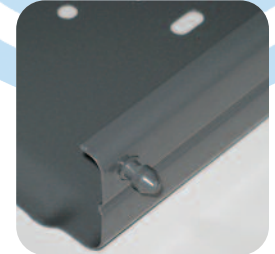

**Truly Adjustable Shelves** All you need is a phillips screwdriver! Simply remove two bolts from the speed nut clips that come with the shelf, tilt the shelf upwards, move the shelf to your desired location, insert the rear shelf studs, reattach the bolts and you're done!

**Rear Shelf Studs** unique design lock shelves in place!



## ADSERIES ACCESSORIES

Model	Size/Description
DV14C1	Divider for ADseries/Single
DV14C8	Divider for ADseries/8 Pack
DK3008	8" High Door Kit/AD32LCV
DK3010	10" High Door Kit/AD32LCV
DK4208	8" High Door Kit/AD44LCV
DK4210	10" High Door Kit/AD44LCV
DK4808	8" High Door Kit/AD50LCV
DK4810	10" High Door Kit/AD50LCV
BRK14EPS	End Panel Bracket To Add on Accessories
RKA1	Rail Kit Adapter/See list at right
RKA3	Rail Kit Adapter3/See list at right
RKA4	Rail Kit Adapter4/See list at right
RKABRK1	Rail Kit Adapter/End Panel Bracket/See list
RKABRK2	Rail Kit Adapter/17A
RKANV	Rail Kit Adapter for NV
RKAWTR	Rail Kit Adapter/Welded Tank Racks
RKA919	Rail Kit Adapter/#9, #19, #919 Drawer Units
35325-G	32" Long Shelf
35327-G	44" Long Shelf
35328-G	50" Long Shelf

**RKA1** - Rail Adapter Kit1  
Use with: CB2, CB3, CB4 (uses 2)

**RKA3** - Rail Adapter Kit3  
Use with: #1, #12, #2, #8, DC Units, 17A, CRH2, TA19, TA5

**RKA4** - Rail Adapter Kit4  
Use with: CL1446D/R, #40, KDRH2, KD Shelving Units, #33, #3, #33W, JD Shelving

**BRK14EPS** - ADseries end panel accessory attachment bracket.  
Use with: 17A, CB5, 43, TA19, TA20, WRH5, UH10/25/50, PA9, PA8, ACT3/4, PA11, AGSCH2, PA7, TH30, TH50, TA5

**RKABRK1** - Used with TA19, TA20, TA5

Note: Rails are not included with the shelf units. Rail kits must be ordered separately

Note: Shelves have the following weight rating:

Shelves positioned with the shelf lips facing up have a rating of 100lbs per shelf evenly distributed.

Shelves positioned with the shelf lips facing down have a rating of 200lbs per shelf evenly distributed.



# PARTITIONS

## ADRIAN STEEL PARTITIONS KEEP CARGO WHERE IT BELONGS, IN THE CARGO AREA!

Stamped steel partitions are available for both Nissan NV Cargo Standard and High Roof vans. The perforated panels allow for side and rear visibility, while increasing cab area climate control. Max Comfort Wing Kits allow for 3 inches of additional front seat adjustability for more cab and leg room. Partition accessories can be attached for easy reach.



Shown:  
S1M2C2FSV  
High roof partition  
with WKC1LCVH  
wing kit.



### Max Comfort Wing Kit

Partition setback allows for 3" of additional front seat adjustability for more cab and leg room. (Reduces cargo space by 3".)

### S-M-C Series Partitions

Choose from solid or perforated top panels made from 18-gauge steel for strength and finished in a tough Steel-Cote powder coat paint. Center M panels can be fixed or hinged with a key-locking door. Partitions are sold as panel kits and wing kits. Please see application chart to confirm the appropriate panel kit and wing kit for your vehicle. Partition panel kits and wing kits include assembly and installation fasteners for base van trim level. Higher trim levels may require modifying trim or partition.

Note: Extended wing kits reduce the amount of cargo space. Please confirm the interior layout of the van package to confirm that the extended wing kit has adequate room needed for installation.

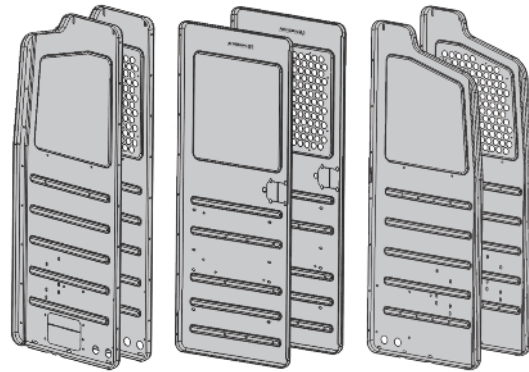

**S1 Solid**  
**S2 Perforated Top**  
Panels mount behind driver seat.

**M1 Solid**  
**M2 Perforated Top**  
Fixed center panels can be hinged as key-locking doors

**C1 Solid**  
**C2 Perforated top**  
Panels mount behind passenger seat.



Shown:  
S1M2C2FSV  
Standard roof partition  
with WKC1LCVS  
wing kit.

### Panel Kit Part Number

#### Fixed Center Panel

**SOLID PANELS**  
S1M1C1FSV

**CENTER PANEL PERF. TOP ONLY**  
S1M2C1FSV

**PERF. CENTER & CURB PANELS**  
S1M2C2FSV

**ALL PANELS PERFORATED**  
S2M2C2FSV

#### Hinged Center Panel "Door"

**SOLID PANELS**  
S1M1HC1FSV

**CENTER PANEL PERF. TOP ONLY**  
S1M2HC1FSV

**PERF. CENTER & CURB PANELS**  
S1M2HC2FSV

**ALL THREE PANELS PERFORATED**  
S2M2HC2FSV

#### Wing Kits

##### STANDARD ROOF

WKC1LCVS - MAX CARGO

WKC1LCVS3 - MAX COMFORT

##### HIGH ROOF

WKC1LCVH - MAX CARGO

WKC1LCVH3 - MAX COMFORT

# PARTITION ACCESSORIES

**ADRIAN ACCESSORIES FULLY UTILIZE YOUR PARTITION SPACE.**



**CB2 Two Book File** has hinged retaining straps. Mounts to floor or other horizontal surface. **Overall size: 6" W, 14" H, 9 3/4" D.**

**PA7 Triangle Reflector Kit** comes with a metal pocket holder, I.C.C. approved.

**PA10 Practice Holder** is a partition-mounted holder for forms, manuals or work related papers. **Overall size: 12" W, 7" H, 5" D.**

**PA8 1-A: 10-BC Fire Extinguisher** is a rechargeable, 2-1/2 lb. dry chemical extinguisher. Stops Class A, B and C fires. Complete with charge gauge and mounting bracket.

**PDK1 Door Kit** converts M-Series fixed center panel into hinged door with keyed slam latch. Includes two 6" hinges, bulb seal and a slam latch. These features reduce vibration noise.

**Plexiglas Partition Cover Panels** (not shown)

**PA5-1** fits S panel

**PA5-2** fits M panel

**PA5-6** fits C panel

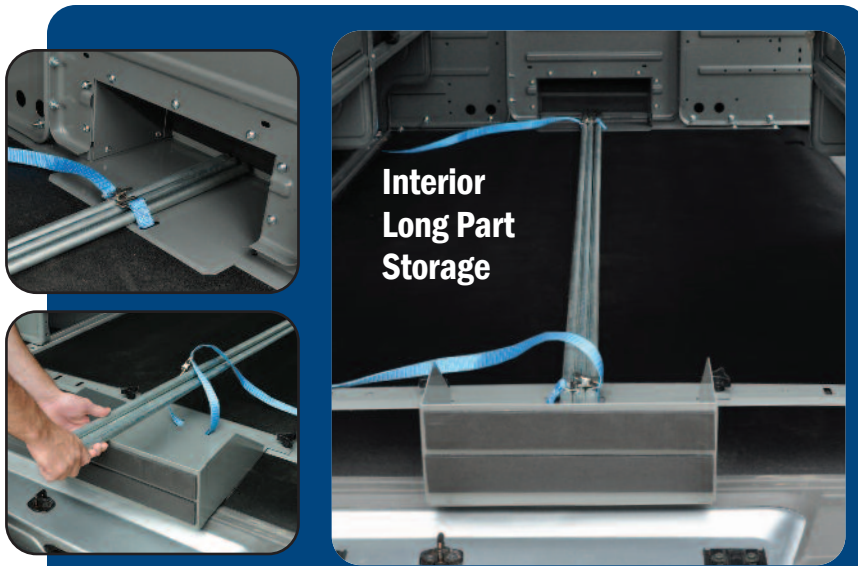

**Interior Long Part Storage**

**Carry 10 feet of conduit or pipe inside your NV Cargo with the Long Part Storage Kit!**

The modified middle partition panel has an extended box which has a 13 3/4" wide by 5 3/4" high opening in the M panel. Tie down straps are provided at the front and the rear of the product to secure the load. The rear tray is positioned to contain the cargo and protect the rear doors. Fits late model Adrian Steel SMC partitions only. Not compatible with hinged door partition option.

Model	Description
M1FLP	M1 panel w/Long Parts Storage Kit
M2FLP	M2 panel w/Long Parts Storage Kit
S1M1C1FLP	S1M1C1 Panel Kit w/Long Parts Storage Kit
S1M2C1FLP	S1M2C1 Panel Kit w/Long Parts Storage Kit
S1M2C2FLP	S1M2C2 Panel Kit w/Long Parts Storage Kit



**TA1 Hook Bar** maximizes vertical storage space. 2" x 12" bar mounts to partition or other vertical surfaces. Four welded hooks with 2" hanger opening.



**File Management for Important Documents**  
**PA11 Cab File Box** mounts to partition or other vertical surface.  
**Overall size: 14" W, 10-1/2" H, 3-1/2" D.**



**TH30 Refrigerant Tank Holder** 30 lb.-holds tank to partition or other vertical surface.

**TH50 Refrigerant Tank Holder** 50 lb.-holds tank to partition or other vertical surface.



**PA9 First Aid Box Tray** secures first aid box to partition or other vertical surface.  
**Overall size: 9" W, 3-1/2" H, 3" D**



# CABINET MODULES

## SPECIFIC JOBS DEMAND SPECIFIC STORAGE SOLUTIONS.

Cabinet and Drawer Modules provide secure storage for large and small tools and parts. The modular design allows you to get what you need now and the ability to add more when you need it. What ever the job demands, Adrian has the storage solutions to transport your gear safely and securely.



### Tank Cabinets

- Provide vented storage for Propane, Mapp gas or CO2 tanks.
- Cabinets feature a full door gasket with two snap latches for positive door closure.
- Interior cabinet cradle and retaining straps (foam yokes for TA19) secure tanks and prevent movement.
- Floor vent and tubing are included for exhausting fumes.
- Propane cabinets store 20, 30 or 40 lb. tanks.
- Mapp Gas Cabinets store 6 1/2" diameter tanks.
- CO2 Tank Cabinets store 20 lb. cylinders.

Model	Description	Cabinet Size
TA18	Propane Cabinet	14-3/4"W x 36"H x 13"D
TA19	CO2 Tank Cabinet	13"W x 32"H x 12-1/2"D
TA20	Mapp Gas Cabinet	14"W x 26"H x 8"D

Vented gas storage solutions



Folding T handles don't stick out into aisles.

### Shelf Cabinets

- Available in 12" and 18" front to rear lengths
- Can be used free standing or stacked with our lockable drawer units.
- Feature locking recessed tee-handles for secure storage and receive a durable gray powder coat finish.
- Cabinets feature an open side and can be combined for side-by-side use holding items up to 35" long.
- Optional end panel can be added to close off side when required.
- Include an adjustable shelf that can be removed
- Optional foam liner kits can be added for extra protection and vibration reduction.
- Cabinets provide a solid surface to stack modular drawers, cabinets and bins.

Model	Description	Cabinet Size
1	Shelf Cabinet	18"W x 22"H x 18"L
12	Shelf Cabinet Open Side	18"W x 22"H x 12"L
1A	Optional Shelf	No. 1
12A	Optional End Panel	No.12
FL1	Optional Foam Kit	No. 1
FL12	Optional Foam Kit	No. 12



### Cabinet Lockers

- Full-door Lockers feature a 46" high storage space with 3 removable shelves.
- Short-door Lockers feature a 33" high storage area and with 2 removable shelves.
- Locker doors are reversible for flexibility and feature locked recessed T-handles for security.
- Cabinet Lockers taper from 14" to 12" from front to back in depth at top and bottom to maximize aisle space.

Model	Description	Cabinet Size
CL1446R	Cabinet Locker Full Door	18"W x 46"H x 14"D
CL1446D	Cabinet Locker Short Door	18"W x 46"H x 14"D

# DRAWER MODULES



2-1/2" deep drawers come with ABS divided and removable trays perfect for small parts.

**NEW GLIDES!**

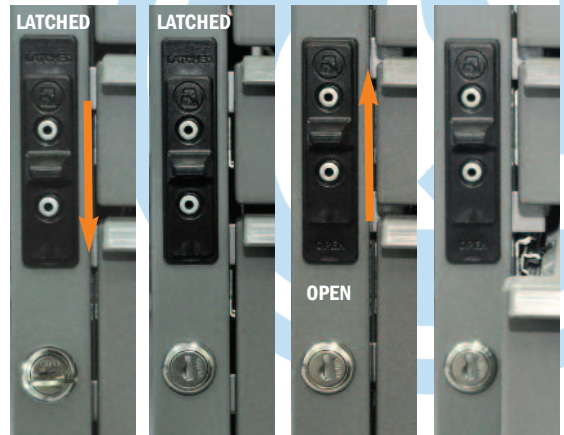

**Latched & Locked**      **Latched & Unlocked**      **Drawers Unlatched**      **Drawers Open**

## Drawer Units - Lock 'n Latch System

- Our exclusive Lock 'n Latch system provides a choice of drawers open, drawers retained or drawers locked position.
- Drawers are made of an engineered composite material for durability with ALL NEW heavy-duty drawer glides for support and smoother drawer operation.
- The new drawer glides significantly increase the ease of use when opening and closing the drawer units. They all but eliminate the rattle noise of the drawers when the driving the vehicle.
- Drawers and glides can be repositioned within cabinet for increased flexibility.
- Divide 5" deep drawers into compartments using optional metal "egg crate" dividers.
- Optional Fitted Foam Kits cover side and bottom of 5" drawers for extra protection.

Model	Description	Drawer Size (Qty.)
19	2 Drawer Medium	16"W x 5"D x 11-1/2"L (2)
919	3 Drawer Combo	16"W x 2-1/2"D x 11-1/2"L (2) 16"W x 5"D x 11-1/2"L (1)
9	4 Drawer Shallow	16"W x 2-1/2"D x 11-1/2"L (4)
27	Divider Kit	Nos. 19 or 919 Drawer (1) 13-3/4"W x 2-3/4"H x 11-3/4"L
FL19	Foam Liner Kit	No. 19 Drawer (1) or 919 Drawer (1)

Steel outer cabinet measures 18"W x 12"H x 12"L.

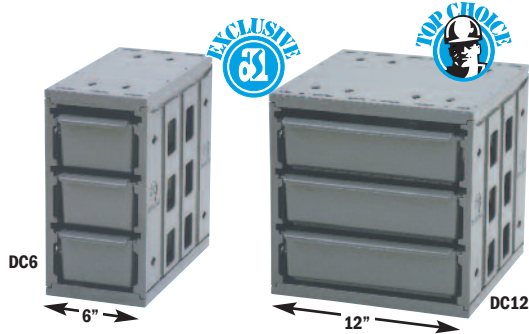

## Drawer Components

- Organize small parts with our flexible and rugged composite Drawer Components.
- Drawer retention stops prevent drawers from opening while the vehicle is in transit.
- The interlocking feature allows you to add multiple units vertically or horizontally.
- Made of a hi-impact polymer for a quiet operation.
- Each drawer comes with 2 dividers and 7 divider slots.
- Choose from Adrian Steel's pre-configured drawer systems or create your own drawer system from the base models.

Model	Description	Overall Size
DC6	Base 3 drawer narrow model	6"W x 12"H x 12"D
DC12	Base 3 drawer wide model	12"W x 12"H x 12"D
DS06212V	Drawer System (2) DC12's	12"W x 24"H x 12"D
DS36012H	Drawer System (3) DC6's	18"W x 12"H x 12"D
DS46012	Drawer System (4) DC6's	12"W x 24"H x 12"D

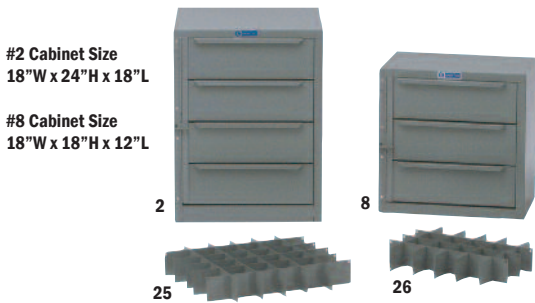

## Drawer Units - Locking Hinge and Hasp

- Drawers are welded and have reinforced drawer slides for strength.
- Can be locked with a padlock (not included) for security.
- Divide drawers with optional metal "egg crate" dividers.
- Optional Foam Liner Kits cover sides and bottom of drawers for extra protection.

Model	Description	Drawer Size (Qty.)
8	3 Drawer Medium	16"W x 5"D x 11-1/2"L (3)
2	4 Drawer Medium	16"W x 5"D x 17-1/2"(4)
25	Divider Kit	No. 2 Drawer (1) 15-1/2"W x 2-3/4"H x 17-1/2"L
26	Divider Kit	No. 8 Drawer (1) 15-1/2"W x 2-3/4"H 11-1/2"L
FL2	Foam Liner Kit	No. 2 Drawer (1)
FL8	Foam Liner Kit	No. 8 Drawer (1)



Portable trays

## Tote Trays and Cases

- Take small parts and tools right to the job site with removable tote trays and cases.
- Totes measure 18-1/2"W x 3"D x 12-1/2"L and are available in both steel tray and poly case designs.
- Steel tote trays feature fold-down carry handles and four large storage compartments with adjustable dividers.
- Poly tote cases offer a see-through lid with latches to prevent spilling,, four large compartments and twelve adjustable dividers.
- Trays and cases store in a 19-3/4"W x 20-1/8"H x 13-3/8"L modular rack that can be stacked or floor mounted.

Model	Description	Tote Style (Qty.)
SPT-4	Combo Totes and Rack	Steel Trays (2) Poly Cases (2)
SPT-4P	Poly Totes and Rack	Poly Cases (4)
SPT-4S	Steel Totes and Rack	Steel Trays (4)
SPT-S	Additional Steel Tray	
SPT-P	Additional Poly Tote	



# CARGO VAN ACCESSORIES



## ADRIAN'S BLUE BIN SYSTEM IS PERFECT FOR VISUAL INVENTORY MANAGEMENT.

- 6" and 12" bins maximize the ADseries shelf space.
- The innovative rail system locks the bins in place on the shelf.
- The bins can nest on top of each other when at the job site or in the warehouse getting filled to go.
- Add a label to the front so you can find parts quickly
- Each bin can accommodate one optional divider.

Order our predefined bin systems or create your own configuration of bins. Please note that the bins and the rail are a system. To obtain all the features listed above, both must be ordered.



SBIN120614



SBIN060614



BR36212 Bin System on an AD44LCV ADseries shelf unit.

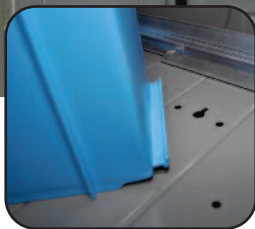

Bins lock into place along the rail for secure transport.

## SAFELY TRANSPORT REFRIGERANT TANKS.



Freon Tank Holder TH51FP

Accommodates a combination of any three 30 or 50 lb tanks.

Straps secure tanks for safe transportation.

### Blue Bin Systems

Model	Description
SBIN060614	6" Blue Bin
SBIN120614	12" Blue Bin
SBINDIV	Divider
BR36212	Bin System: 3-6" & 2-12" bins w/rail
BR76012	Bin System: 7-6" bins with rail
SRAILAD26	26" Retention rail
SRAILAD32	32" Retention rail
SRAILAD44	44" Retention rail
SRAILAD50	50" Retention rail

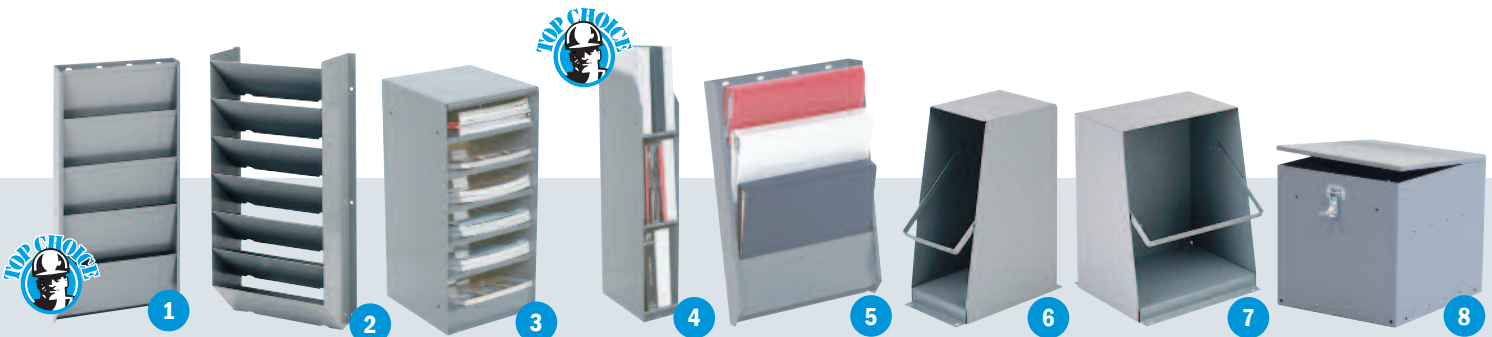

**1: CB5 Five Slot Literature Holder** Mount on partition or other vertical surface. 2-1/2" deep pockets. Overall size: 12"W, 24"H, 2-1/2"D.

**2: CB7 Seven Slot Literature Holder** Mount on partition or other vertical surface. 6-3/4" deep pockets. Overall size: 14-3/4"W, 28-7/8"H, 7"D.

**3: 17A Six Shelf Catalog File** Designed for catalogs but also serves to store a variety of materials between the 3" shelf spacings. Overall size: 11"W, 24"H, 12"D.

**4: 43 Three Shelf Catalog File** Fits in narrow spaces. It has three tilted shelves. Perfect for binders and catalogs. Overall size: 6" W, 34" H, 12" D.

**5: BH4 Four Slot Binder Holder** Designed to mount on partition or almost any vertical surface. Excellent for binders. Each pocket is 2 1/2" deep.

Overall size: 12-3/4" W, 19-1/2" H, 2-1/2" D.

**6: CB2 Two Book File** Mounts on the floor between front seats and partition. Holds folders 12"H x 10-1/2"D. Overall size: 6"W, 14"H, 12"D.

**7: CB3 Three Book File** Mounts on cabinet tops or on the floor. Multiple units can be flush-mounted. Holds folders 12"H x 10-1/2"D.

Overall size: 10-3/4"W, 14"H, 12"D.

**8: CB4 Utility Storage Box** Stores a variety of printed material. Also suitable for keeping tools, safety glasses, gloves and other items. Hinged lid. Overall size: 12"W, 12"H, 14"D.

# CARGO VAN ACCESSORIES

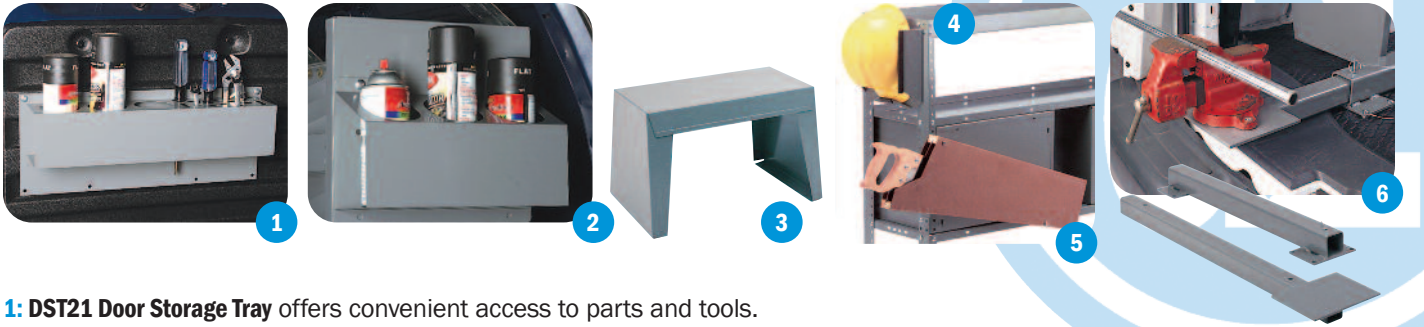

**1: DST21 Door Storage Tray** offers convenient access to parts and tools.

Overall size: 20" W, 4" D, 8" H

**2: Aerosol Can Tray** secure cans for easy access.

**ACT3** - 3 Can Tray Overall size: 11-3/4" W, 4" D, 6-3/4" H

**ACT4** - 4 Can Tray Overall size: 15-7/16" W, 4" D, 6-3/4" H

**3: 14 Step Stool** has a wide base and is 12" high. Stool can be used as a workbench or auxiliary step. Top measures 10" x 20" One size.

**4: TA2 Hard Hat Holder** secures hat to partition or shelving.

**5: TA3 Saw Holder** holds two hand saws.

**6: VMA36 Vise Mount Assembly** is floor mounted and telescopes out beyond side or rear cargo doors when fully opened. Measures 36" closed and 60" open.

**7: Touch-Up Paint** in spray cans match Steel-Cote™ finish. Three colors:

**STP12G** - Gray **STP12W** - White **STP12B** - Black

**8: Door Tray** comes with two dividers and has optional lid for containment.

**DT21** - Door Tray Overall size: 18" W, 4" D, 4" H

**DTL21** - Door Tray Lid for DT21 only

**DTWL21** - Door Tray with Lid Overall size: 20" W, 4" D, 4" H

**9: Parts Tray** features a 2" deep shelf lip. Can be mounted to cabinet and drawer modules for added top storage.

**4A** - Parts Tray Overall size: 36" W, 12" D, 2" H

**4B** - Parts Tray Overall size: 18" W, 12" D, 2" H



Storage for small parts

## REEL HOLDERS

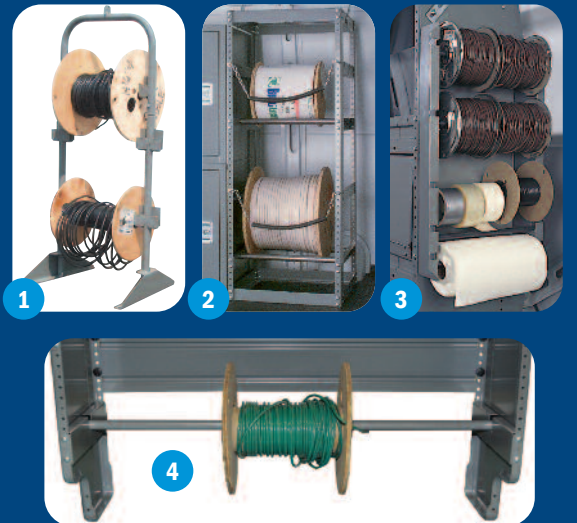

**1: CRH2 Cable Reel Holder** features a durable frame, two steel shafts that holds up to a 15-1/2" diameter reel by 14" wide. Overall size: 19-1/8" W, 16" D, 44-7/8" H

**2: KDRH2 Cable Reel Holder** holds large spools up to 16" wide and 18" in diameter. Spools nest on conveyor rollers. Includes tie-down chains with neoprene covers. Overall size: 18" W, 46" H, 18" D

**3: WRH5 Wire Reel Holder** Five removable bars hold wire spools up to 6" in diameter. Reel Holder mounts to shelf ends or any vertical surface. Overall size: 12" W, 25" H, 4" D

**4: End Panel Reel Holder** Bar mounts between ADseries shelf end panels for easy access to spools of cable and wire.

**KDRH1426** - fits 26" shelf  
**KDRH1444** - fits 44" shelf

**KDRH1432** - fits 32" shelf  
**KDRH1450** - fits 50" shelf



**Wire Window Screens** add security to cargo area windows.

**60-NRD** Nissan NV Rear Door Kit

**60-NSDRD** Nissan NV Side & Rear Door Kit



### Hooks

Model	Description
UH10	1" hook
UH25	2-1/2" hook
UH50	5" hook
TA1	4 Hook Bar

### Cargo Straps

Model	Description
CS9	9" strap
CS15	15" strap
CS21	21" strap
CS31	31" strap



# LADDER RACK OPTIONS

## LOADSRITE DROP-DOWN LADDER RACK

### LOADING LADDERS JUST GOT DOWN RIGHT EASY.

Adrian's LOADSRITE Ladder Racks easily raise and lower to eliminate the need to climb, stretch or reach for your ladder on top or your NV Cargo Standard Roof. The unique design of the LOADSRITE presents the ladder in a diagonal position bringing it to a comfortable working height.

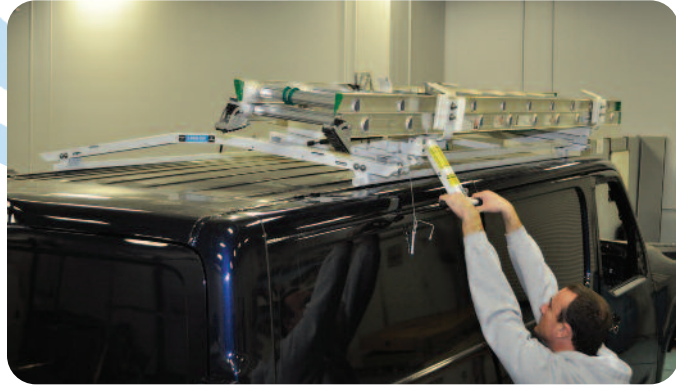

1. Easy Reach Handle

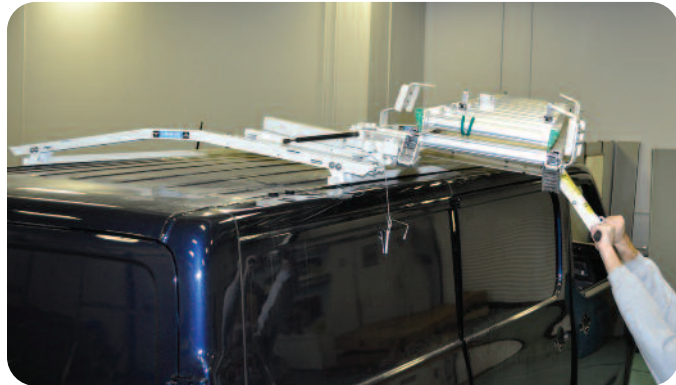

2. Glide-Out Bed Platform

### NV CARGO STANDARD ROOF

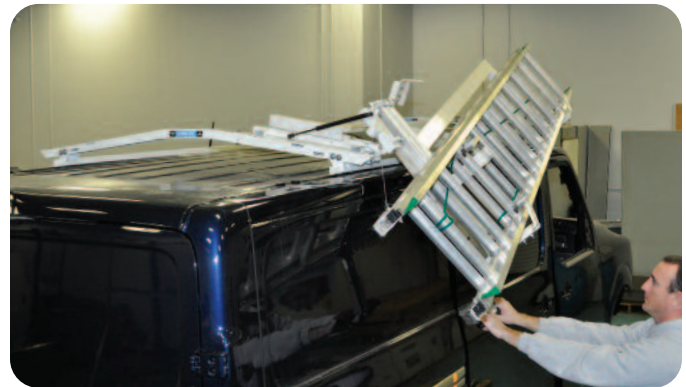

3. Hydraulic Load Assist

**LOADSRITE**  
Keeps loading and  
unloading from being  
a pain in the back.

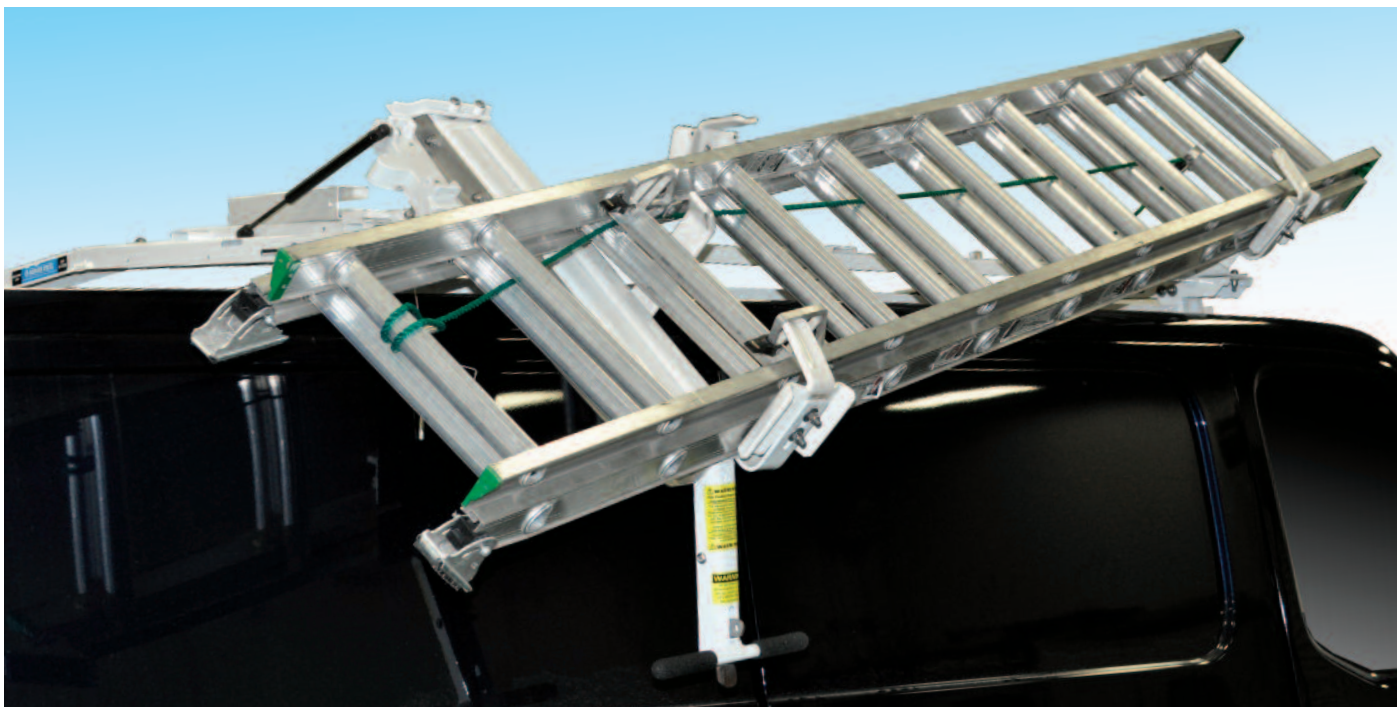



# LADDER RACK OPTIONS

## LOADSRITE DROP-DOWN LADDER RACK

### LOADSRITE FEATURES & BENEFITS

- Designed to allow ladders to be loaded and unloaded one end at a time.
- Ladder clamps securely hold the ladder for transportation.
- Ladders can be padlocked for added security.
- Clamping of ladder is automatic.
- Aluminum bed frame, cast aluminum grab handle, stainless steel latch and fasteners.
- Rollers and dampers create a smooth transition to the stowed and down positions.
- The easy-reach release handle lowers toward the ground for better access (high roof.)
- Two handed operation is required to release the ladder for safer loading and unloading.
- Plastisol clamps and plastic pads protect fiberglass ladders.
- The LoadsRite for the Nissan NV Cargo can carry 16' - 36' extension ladders

**LCVLR-S61** Single LoadsRite (curbside) -std. roof

**LCVLR-S63** Double LoadsRite -std. roof

**LCVLR-H61** Single LoadsRite (curbside) -high roof

**LCVLR-H63** Double LoadsRite -high roof



1. Rotate Handle



2. Primary Drop



3. Secondary Drop



4. Unload Ladder

### NV CARGO HIGH ROOF



Scan to see  
the LoadsRite  
in action!



# LADDER RACK OPTIONS

## EZ LOAD LADDER RACK

### EZ LOAD LADDER RACK BY ADRIAN STEEL

Designed with the average height person in mind, the EZ Load Ladder Rack is the most functional, easy to use grip lock style ladder rack on the market.

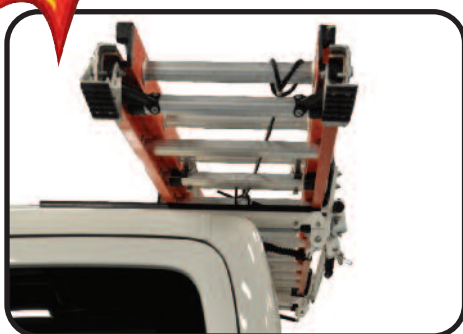

UP & LOCKED POSITION

#### EZ to Operate

Loading ladders just got easier! Taller cargo vans and longer ladders make it difficult to load ladders, until now. The EZ Load rack's patent pending design brings the rack down 6" towards you so you don't have to reach the roof of your van to load and unload ladders. Much closer than any comparable grip lock rack on the market today.

#### EZ to Adjust

Ladders come in all shapes and sizes. The EZ Load ladder rack has one common fastener versus comparable grip lock racks with different fasteners for different brackets. All you need to adjust your EZ Load Rack for your ladders is a 1/2" socket.



LOWERED POSITION

#### EZ to Maintain

Corrosion Free! The all aluminum design with stainless steel fasteners allow the EZ Load to look great for years to come!

#### EZ to Accessorize

The new T-Slot design makes adding accessories EZ! Add a stepladder kit, conduit carrier or utility rack kit with ease!



Crossbar with T-Slot and square-head bolts.



Plastisol coated brackets and plastic contact surfaces protect ladders from excessive wear.

# LADDER RACK OPTIONS

## EZ LOAD LADDER RACK



### NEW DESIGN OFFERS BETTER ERGONOMICS!

Cargo vans are getting taller each year and most grip lock style ladder racks do not take this factor into their design. The average height person in North America is 5'8" (according to the CDC) and the taller the cargo vans get, the harder it is to load a ladder on top of these vans. The patent pending design of the EZ Load Ladder Rack brings the ladder down 6" towards the operator. Making it easier to reach when you unload and more importantly, when the operator has to load the ladder, they no longer have to lift the ladder to the top of the cargo van reducing the risk of injury!

- **Ladder Protection** – Ladders stowed on the EZ Load Ladder Rack are protected with composite plastic that keep fiberglass ladders from rubbing on the metal of the ladder rack. This prolongs the life of your fiberglass ladders.
- **Safe Ladder Transportation** – No bungee cords needed. Four brackets secure the ladder tightly in place during transportation. Proper adjustment should take place when you first load your ladders on the EZ Load Rack.
- **Ladder Security** – Ladders can be secured against theft with an optional padlock.
- The EZ Load Ladder Rack accommodates 10' – 36' extension ladders and 8' step ladders. Shorter ladders can be accommodated with the optional step ladder kit.



**Pull to release the handle, swing out and down to lower ladder.**



**Lift ladder off the rear bracket.**



**Scan to see the EZ Load in action!**

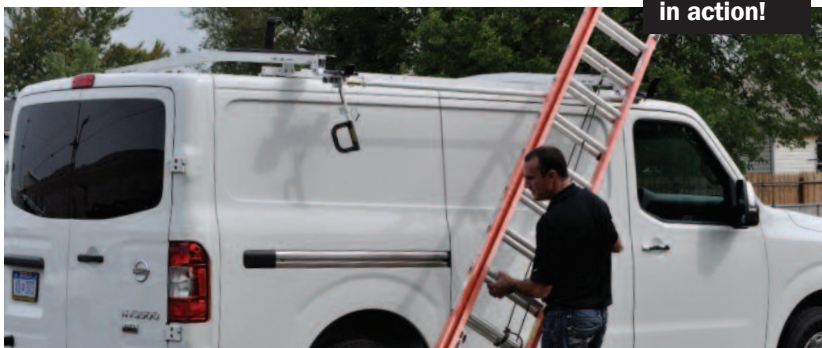

**Lower ladder to the ground, resting the top of the ladder on the front bracket.**

Model	Description
61-EZLCVC	EZ Load Single Curbside
61-EZLCVS	EZ Load Single Streetside
63-EZLCV	EZ Load Double
LR64EZCLCV	LoadsRite Combo (curb drop-down)
68-EZLCV	Step Ladder Kit
64-EZLCV	Combo w/ Step Ladder Kit
65-EZ	Utility Rack Add-on Kit
LR6200WSF	LoadsRite Add-on Kit (streetside)*
LR6200WCF	LoadsRite Add-on Kit (curbside)*
70-1EZ	4" PVC Conduit Kit
70-2EZ	6" PVC Conduit Kit
80-1EZ	10' Aluminum Conduit Carrier
80-2EZ	12' Aluminum Conduit Carrier

\*Order with BAGLR64EZ



# UTILITY RACK & LADDER KEEPER OPTIONS

MAXIMIZE YOUR CARGO CAPACITY WITH AN ALUMINUM UTILITY RACK.

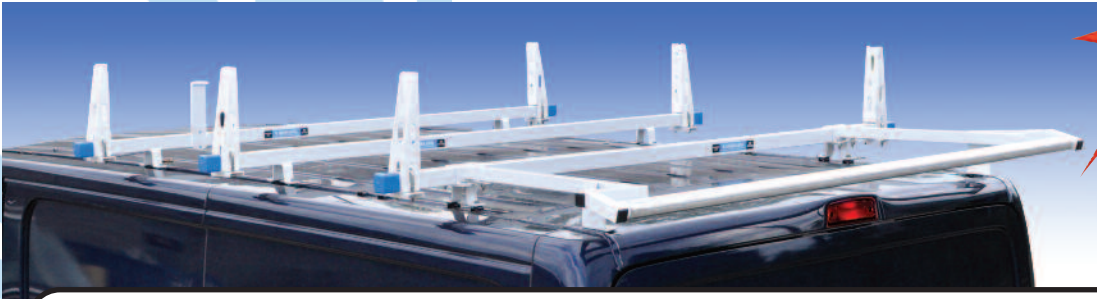

## UTILITY RACK FEATURES & BENEFITS

- This all aluminum rack is designed to reduce corrosion by eliminating much of the welding.
- The uprights are fully plastisoled to protect against wear and reduce ladder fatigue.
- Uprights feature many attachment points for securing cargo straps.
- Weather resistant cross bar is not cut to fit or perforated in any way improving longevity of the rack.
- The Rear Roller Bar eases the loading and unloading of the rack. The Rear Roller comes standard with the 2 and 3 Bar racks.
- Available in our durable black or white powder coat paint.
- Optional center bars support shorter lengths and provide additional support.
- The Nissan NV Cargo can accommodate 2-5 cross bars.

Model	Description	Color
3BARRNV-B	3 Bar Utility Rack	Black
3BARRNV-W	3 Bar Utility Rack	White
2BARRNV-B	2 Bar Utility Rack	Black
2BARRNV-W	2 Bar Utility Rack	White
1BNLCV-B	1 Crossbar	Black
1BNLCV-W	1 Crossbar	White
RRBLCV-B	Rear Roller Kit	Black
RRBLCV-W	Rear Roller Kit	White
80-1	Aluminum Conduit Carrier 10' 6"	
80-2	Aluminum Conduit Carrier 12' 6"	



## ALUMINUM CONDUIT CARRIER

The two piece design features a lift-up door with a spring assist for easy access and lockable swivel closure. Constructed with .063" diamond tread aluminum with a bolt-on plate at the front to allow access to the front end of the carrier.

STORING LADDERS INSIDE YOUR VAN IS EASY AS 1, 2, 3, WITH OUR LADDER KEEPER.



**Ladder Keeper** is designed to be loaded from outside the vehicle, the Ladder Keeper features a spring-loaded clamp that holds the ladder securely in place. Just set the top of the ladder in the front clamp bracket and push it forward until the bottom of the ladder sits in the rear clamp bracket. Mounts to the ceiling of the van to securely transport ladders inside and out of the elements. Includes all parts needed to carry up to a 6 foot ladder.

**LKLCV** - Ladder Keeper Interior Ladder Rack for Nissan NV Cargo



- A** Plastic coated clamps protect ladder rungs
- B** Gas spring compresses ladder for quiet and secure transportation
- C** Extruded track makes loading and unloading simple



Keep ladders out of the elements and off the floor.



**1** Simply press ladder inward to release rear ladder rung from the rear clamp bracket.



**2** Walk the ladder back as the front clamp bracket glides on the track.



**3** Remove front rung from the front clamp bracket and you're ready to go to the job site!

# INDEX

Model	Page	Description
ACT3	17	Aerosol Can Tray
ACT4	17	Aerosol Can Tray
AD26LCV	11	26" ADseries-Nissan
AD32LCV	11	32" ADseries-Nissan
AD44LCV	11	44" ADseries-Nissan
AD50LCV	11	50" ADseries-Nissan
BH4	16	Binder Holder
BR36212	16	Bin System
BR76012	16	Bin System
BRK14EPS	11	End Panel Bracket
CB2	13,16	Two Book File
CB3	16	Three Book File
CB4	16	Utility Storage Box
CB5	16	Literature Holder
CB7	16	Literature Holder
CL1446D	14	Cabinet Locker
CL1446R	14	Cabinet Locker
CRH2	17	Cable Reel Holder
CS9	17	9" Cargo Strap
CS15	17	15" Cargo Strap
CS21	17	21" Cargo Strap
CS31	17	31" Cargo Strap
DC6	15	Drawer Component
DC12	15	Drawer Component
DK3008	11	8" Door Kit/AD32LCV
DK3010	11	10" Door Kit/AD32LCV
DK4208	9,11	8" Door Kit/AD44LCV
DK4210	11	10" Door Kit/AD44LCV
DK4808	11	8" Door Kit/AD50LCV
DK4810	11	10" Door Kit/AD50LCV
DS06112V	11	Drawer System
DS36012H	15	Drawer System
DS46012	15	Drawer System
DST21	17	Door Storage Tray
DT21	17	Door Tray
DTL21	17	Door Tray Lid
DTWL21	17	Door Tray w/Lid
DV14C1	11	Divider, Single
DV14C8	11	Divider, 8 Pack
FL1	14	Foam Liner
FL2	15	Foam Liner
FL8	15	Foam Liner
FL12	14	Foam Liner
FL19	15	Foam Liner
HD32NVH	10	32" Adjustable Shelf Unit
HD42NVH	10	42" Adjustable Shelf Unit
HD52NVH	10	52" Adjustable Shelf Unit
KDRH1426	17	End Panel Reel Holder
KDRH1432	17	End Panel Reel Holder
KDRH1444	17	End Panel Reel Holder
KDRH1450	17	End Panel Reel Holder
KDRH2	17	Reel Holder
LCVLR-H61	19	Single LoadsRite - NV high roof
LCVLR-H63	19	Double LoadsRite - NV high roof
LCVLR-S61	19	Single LoadsRite - NV std roof
LCVLR-S63	19	Double LoadsRite - NV std roof
LKLCV	22	Ladder Keeper - Nissan
LR6200WCF	21	LoadsRite Kit Curb/EZ Load
LR6200WSF	21	LoadsRite Kit Street/EZ Load
LR64EZCLCV	21	LoadsRite-EZLoad Combo

Model	Page	Description
M1FLP	13	Long Parts Storage, M1
M2FLP	13	Long Parts Storage, M2
PA5-1	13	Plexiglas Panel
PA5-2	13	Plexiglas Panel
PA5-6	13	Plexiglas Panel
PA7	13	Reflector Flare Kit
PA8	13	Fire Extinguisher
PA9	13	First Aid Tray
PA10	13	Practice Holder
PA11	13	Cab File Box
PDK1	9,13	Partition Door Kit
RKA1	11	Rail Kit Adapter
RKA3	11	Rail Kit Adapter
RKA4	11	Rail Kit Adapter
RKA919	11	Rail Kit Adapter
RKABRK1	11	Rail Kit Adapter
RKABRK2	11	Rail Kit Adapter
RKANV	11	Rail Kit Adapter
RKLCV	11	Rail System Nissan NV
RRBLCV-B	22	Rear Roller Bar Kit-Black
RRBLCV-W	22	Rear Roller Bar Kit-White
S1M1C1FLP	13	Partition w/ Long Part Storage
S1M1C1FSV	12	Partition FSV
S1M1HC1FSV	12	Partition FSV
S1M2C1FLP	13	Partition w/ Long Part Storage
S1M2C1FSV	12	Partition FSV
S1M2HC1FSV	12	Partition FSV
S1M2C2FLP	13	Partition w/ Long Part Storage
S1M2C2FSV	12	Partition FSV
S1M2HC2FSV	12	Partition FSV
S2M2C2FSV	12	Partition FSV
S2M2HC2FSV	12	Partition FSV
SBIN060614	16	6" Plastic Bin
SBIN120614	16	12" Plastic Bin
SBINDIV	16	Plastic Bin Divider
SPT-4	15	SP Tote/Combo
SPT-4P	15	SP Tote/Poly
SPT-4S	15	SP Tote/Steel
SPT-S	15	SPT Steel Tray
SPT-P	15	SPT Poly Tote
SRAILAD26	16	Bin Retention Rail 26"
SRAILAD32	16	Bin Retention Rail 32"
SRAILAD44	16	Bin Retention Rail 44"
SRAILAD50	16	Bin Retention Rail 50"
STP12G	17	Paint, Gray
STP12W	17	Paint, White
STP12B	17	Paint, Black
TA1	13,17	Hook Bar
TA2	17	Hard Hat Holder
TA3	17	Saw Holder
TA18	14	Propane Tank Cab.
TA19	14	CO2 Tank Cabinet
TA20	14	Mapp Gas Cabinet
TH30	13	Tank Holder
TH50	13	Tank Holder
TH51FP	16	Freon Tank Holder-Nissan
UH10	17	Utility Hook
UH25	17	Utility Hook
UH50	17	Utility Hook
VMA36	17	Vice Mount Assembly

Model	Page	Description
WKC1LCVH	12	Wing Kit - Nissan High Roof
WKC1LCVH3	9,12	Wing Kit - Nissan High Roof
WKC1LCVS	9,12	Wing Kit - Nissan Std Roof
WKC1LCVS3	9,12	Wing Kit - Nissan Std Roof
WRH5	17	Wire Reel Holder
1	14	Cabinet
1A	14	Shelf
1BNLCV-B	22	Crossbar/Black
1BNLCV-W	22	Crossbar/White
2	15	Drawer Unit
2BARRNV-B	22	2 Bar Utility Rack
2BARRNV-W	22	2 Bar Utility Rack
3BARRNV-B	22	3 Bar Utility Rack
3BARRNV-W	22	3 Bar Utility Rack
4A	17	Parts Tray
4B	17	Parts Tray
8	15	Drawer Unit
9	15	Drawer Unit
12	14	Cabinet
12A	14	End Panel
14	17	Step Stool
17A	16	Catalog File
19	15	Drawer Unit
25	15	Divider/#2
26	15	Divider/#8
27	15	Divider/#19
43	16	Catalog File
60-NRD	9,17	Window Screen
60-NSDRD	17	Window Screen
61-EZLCVC	21	EZ Load Single Curbside
61-EZLCVS	21	EZ Load Single Streetside
63-EZLCV	21	EZ Load Double
64-EZLCV	21	Combo Step Ladder Kit/EZ Load
65-EZ	21	Utility Rack Kit/EZ Load
68-EZLCV	21	Step Ladder Kit/EZ Load
70-1EZ	21	4" PVC Conduit Kit
70-2EZ	21	6" PVC Conduit Kit
80-1	9,22	10' Aluminum Conduit Carrier
80-1EZ	21	10' Aluminum Conduit Carrier
80-2	22	12' Aluminum Conduit Carrier
80-2EZ	21	12' Aluminum Conduit Carrier
919	15	Drawer Unit
2255NH	8	Locksmith Pkg - High Roof
2255NS	8	Locksmith Pkg - Std Roof
4484	4	Cargo Mgmt Pkg - Std Roof
4485	4	Utility Package - Std Roof
4519	5	Cargo Mgmt Pkg - High Roof
4520	5	Utility Package - High Roof
4686NH	6	Gen Svc Pkg - NV High Roof
4686NS	6	Gen Svc Pkg - NV Std Roof
4687NH	6	Elect Pkg - NV High Roof
4687NS	6	Elect Pkg - NV Std Roof
4688NH	7	Security Pkg - NV High Roof
4688NS	7	Security Pkg - NV Std Roof
4689NH	7	Cable Pkg - NV High Roof
4689NS	7	Cable Pkg - NV Std Roof
4690NH	8	HVAC Pkg - NV High Roof
4690NS	8	HVAC Pkg - NV Std Roof
4957	4	EZ Load Utility Pkg - Std Roof
35325-G	11	32" ADseries Add-on Shelf



# ADRIAN STEEL COMPANY

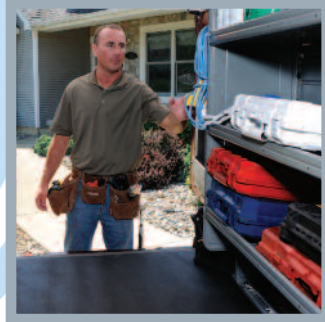

## QUALITY

- Adrian Steel is proud to be the first and only van equipment manufacturer to obtain TS16949 certification.
- Our products are durable and reliable. Warranty claims are less than 1% of sales.
- Our warranty covers our products for three years or 36,000 miles.

## INNOVATIVE PRODUCTS WITH FEATURES THAT MATTER

- Drawers that stay closed while in transit.
- ADseries truly adjustable shelving platform.
- LoadsRite drop-down ladder racks that load and unload the safe and right way.
- Interior ladder storage.
- Plug and Play accessories.
- File storage, removable small parts bins, and much more!



## COMMITMENT

- At Adrian Steel, we are committed to you beyond the upfit!
  - A dedicated Customer Care Team at corporate headquarters.
  - A network of highly qualified distributors to support you locally.
  - Our commitment to provide the best cargo management solutions in North America.

## EXPERIENCE

- **Over One Million vans upfitted**, and counting! It's a fact that an organized vehicle increases work flow efficiencies and reduces inventory damages.
- Recognized as a National Truck Equipment Association MVP.



## SERVICE

- Adrian Steel Products can be purchased throughout North America at authorized Adrian Steel distributors.
- Adrian Steel Customer Service Representatives are available M-F, 8am - 5pm EST at **1-800-677-2726**.
- E-mail us at [info@adriansteel.com](mailto:info@adriansteel.com) with questions, comments and feedback.
- Visit [AdrianSteel.com](http://AdrianSteel.com) for the most up-to-date product information, distributor locator, product catalogs, videos and more.

## PROUDLY DISTRIBUTED BY:



906 James Street  
Adrian, Michigan 49221-3996  
517-265-6194 Fax: 517-265-5834  
Toll Free 800-677-2726  
[adriansteel.com](http://adriansteel.com) [info@adriansteel.com](mailto:info@adriansteel.com)